

BUSINESS ETHICS: ARE NANO PARTICLES A BLESSING OR A CURSE?

Invited Opening Talk at the
8th COSIMP Mercosur
Congress of
Pharmaceutical Sciences
XII CISDEM Forum & IV
EPPGCF Research
Meeting in Pharm. Sci.
Post Graduation Program
of UNIOESTE

Prof. Hans Leuenberger
hans.leuenberger@ufl.edu



BUSINESS ETHICS: ARE NANO PARTICLES A BLESSING OR A CURSE?

Hans Leuenberger, PhD,
Professor emeritus
Pharmaceutical
Technology University of
Basel;

Adjunct Professor,
University of Florida,
College of Pharmacy, Lake
Nona Campus.

hans.leuenberger@ufl.edu



Introduction

Prof. M. Van de Voorde, former Director of CERN, Geneva, and Editor of books on Nano Science & Tech. University of Delft such as Pharmaceutical Nanotechnology

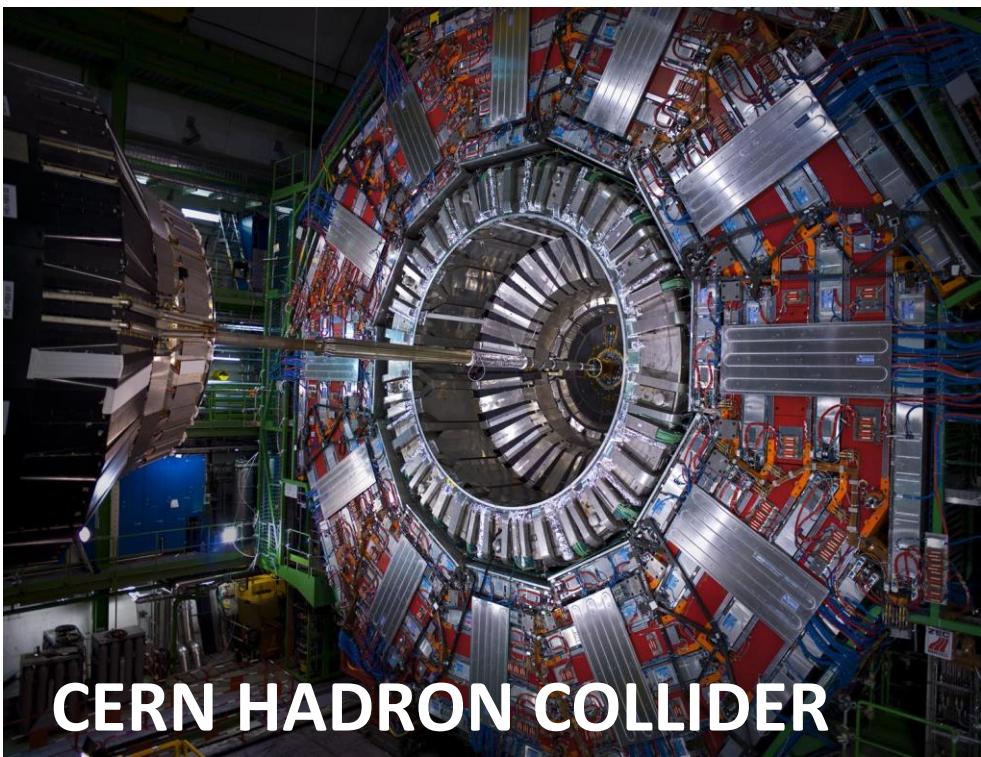

CERN HADRON COLLIDER

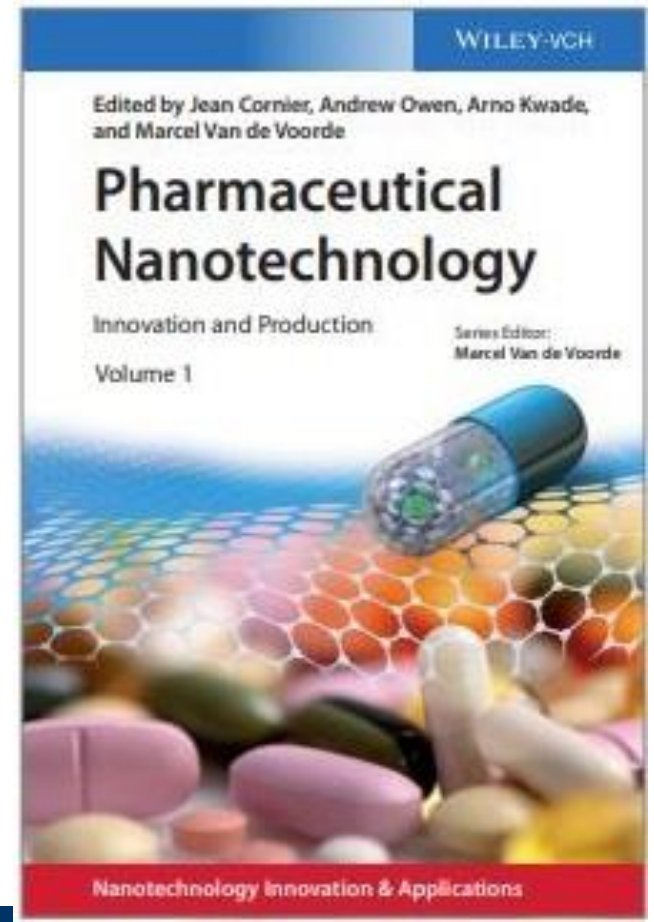

Introduction

M. Van de Voord's book series on Nano Science & Technology cover a wide range of disciplines:

Human Health, Nanophotonics, Food and Agriculture, Magnetism, Energy, Electronics, Catalysis etc.

Thus, the centuries of biology, chemistry, and physics **is followed by**

The century of Nano Science & Technology

Thanks, Foreword

Ethics in NanoTechn. Editors

Gunjan Jeswani & Marcel Van de Voorde (Chapt. 20)

Debate: Nanoparticles –
A Blessing or a Curse?

*Prerequisites for Securing
Public Acceptance of Nano
Technology and Beyond*

*How to find a science based
Solution in a Chaotic World?*

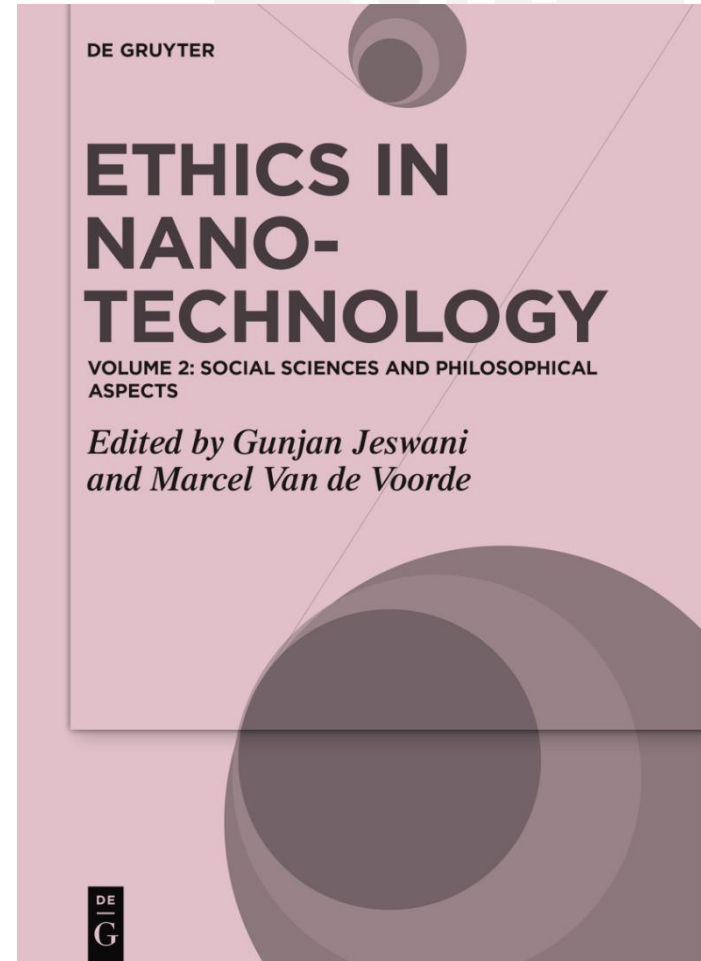

Study based on the work of

I. Prigogine & I. Stengers:

“Order out of Chaos, Man’s New Dialogue with Nature”(U of M, Bantam Books,1984) and on my work in SWISS PHARMA 41 (2019) Nr. 1, 20–36,

”What is Life?”

(pdf available at www.ifiip.ch), that leads to the following axioms, far from Equilibrium Conditions:

1.(Prigogine): *Transformations exist **from disorder into order**, leading to the **creation of life**: Chaos*
➔ *Order.*

“What is Life?”

2.(Leuenberger):The same process is responsible for “inorganic life”, i.e. for the formation of highly ordered crystals in nature: Chaos → Order.



“What is Life?” axioms cont.

3.(Schrödinger): Life = Information = Software = Our Genetic Code (DNA) ↓

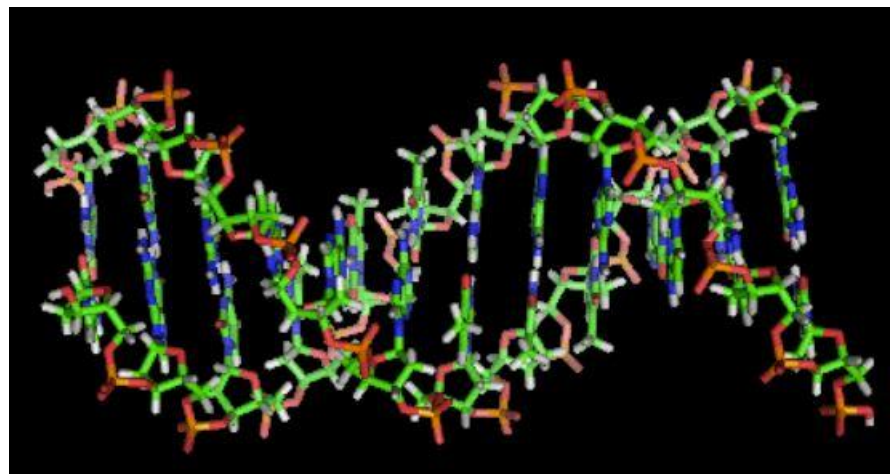

**4.(Schrödinger/ Prigogine):
The human being is a
living (super) computer! →**

The Einstein Quantum Computer

Mathematical Principle and Transition to the Classical Discrete and Quantum Computer Design

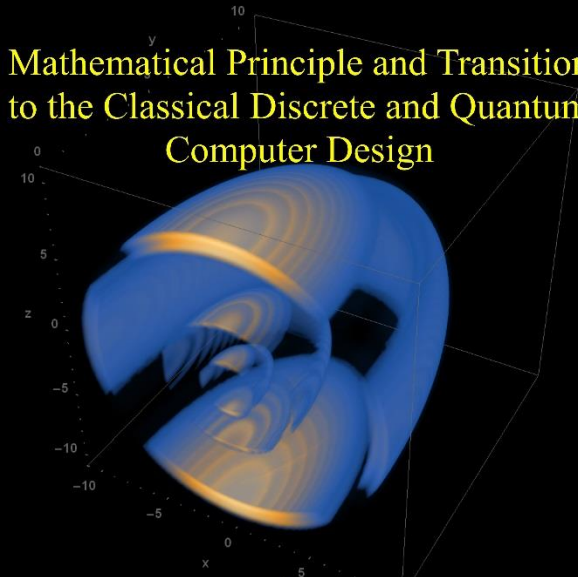

by
Norbert Schwarzzer

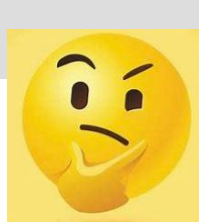

4.(Schrödinger/ Prigogine): = Super Computer?



This is the concept of a *Virtual Patient* based on the idea that each human cell is a microprocessor.

Mitochondrion = power supply of the cell = Microprocessor of the Human Super Computer

Number of cells in the human body $\approx 37.2 \times 10^{12}$ without the Microbiom!

Human Being = a **Multi-processor** = **Super Computer!**

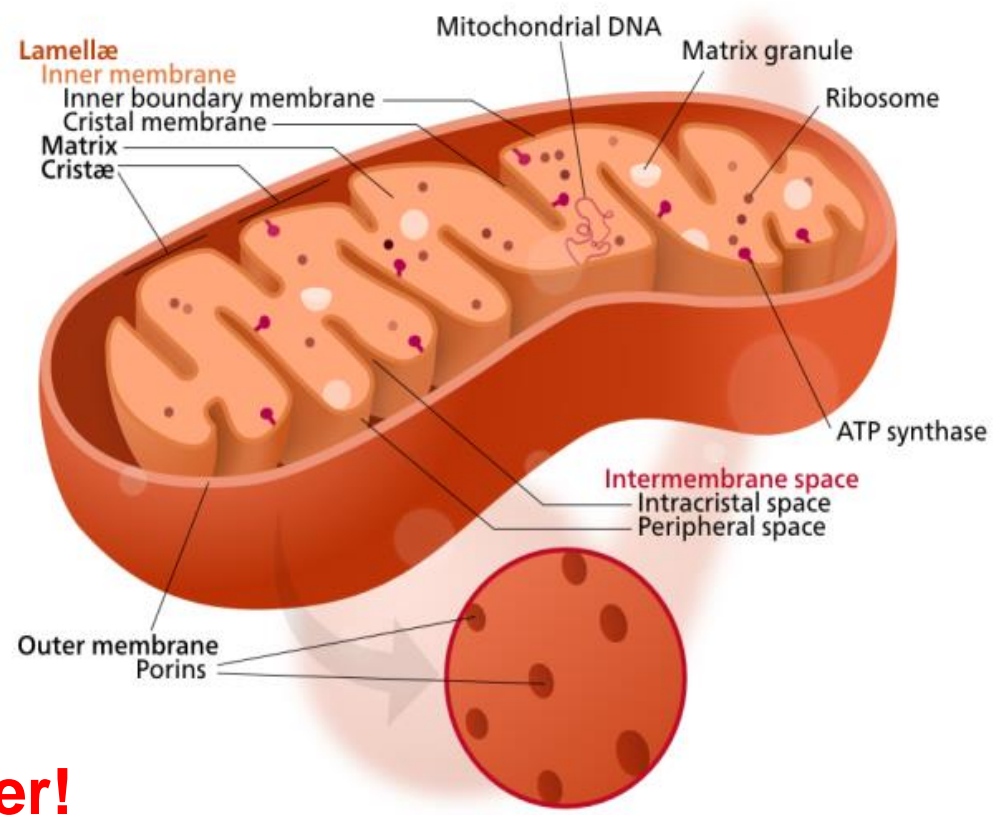

Axioms continued...

5.(Fröhlich): The **evolutionary process uses all existing physical laws of the present (imperfect) standard cosmological model** to find a **niche for a successful survival of the biological system**: e.g. *The mechanism of **collective «mind» of flying birds***



A swarm-like flock of Starlings
([https://en.wikipedia.org/wiki/Flocking_\(behavior\)](https://en.wikipedia.org/wiki/Flocking_(behavior)))

*is similar to a **crystalline phase transition of the Inorganic Life (Axiom 2)!***

Axioms continued...

6.(Zwicky): The evolutionary process uses unknown physical laws **beyond the present standard cosmological model!** The discussion in the framework of understanding “What is Life?” was limited to Homo Sapiens, but Nature shows that this concept can be generalized and extended:

7.(Mandelbrot): Nature’s principle of self-similarity.

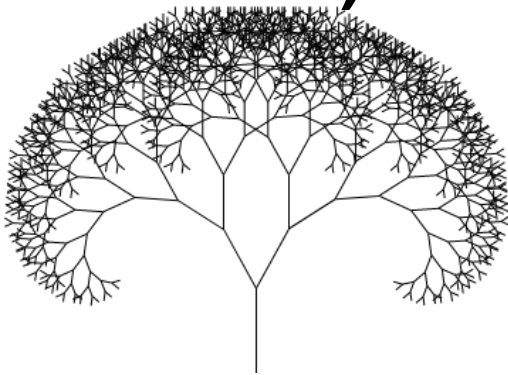

The Fractal World of Mandelbrot
(https://en.wikipedia.org/wiki/Fractal#cite_note-64)

Axioms continued...

8. (Steele/Leuenberger): **Bionic Inspired Philosophical Solutions** based on **Biologically Inspired Engineering (Bionics)** is the application of biological methods found in nature. **Nature is Our Teacher!** 8a: What is the secret of the **Horseshoe Crab** living with Nature **in peace** since **450 million** and the Homo Sapiens since **450 thousand** years?



Limulus Test

(https://en.wikipedia.org/wiki/Horseshoe_crab)

“What is Life?”

Axiom 8 continued...

8b. (Steele/Leuenberger) **Bionic Inspired Philosophic. Solutions with Nature as our Teacher:**

Life and Death of a B. Colony in a closed Habitat.

The Death is the Result of Pollution and Lack of Resources!

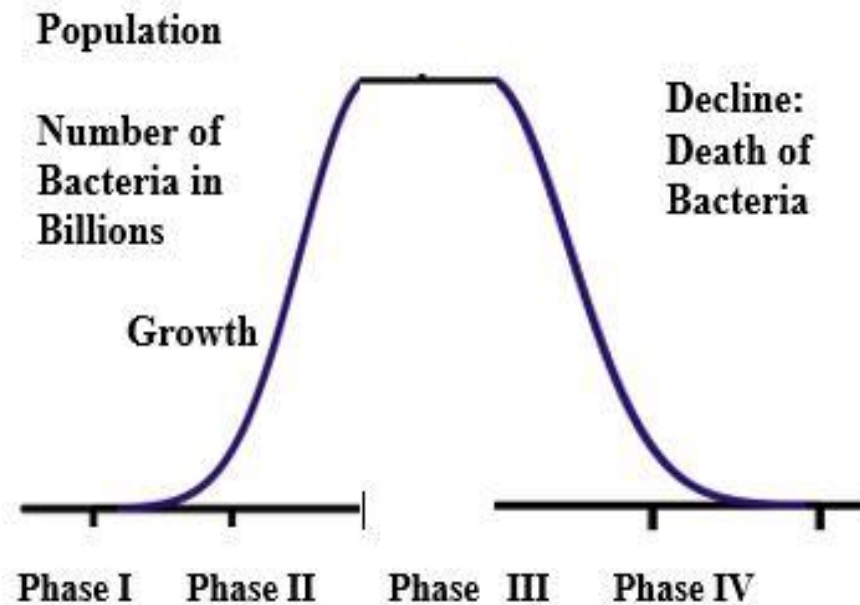

Is this the future of the Homo Sapiens?

Axiom 8 continued...

8c. (Steele/Leuenberger) **Bionic Inspired** **Philosophic. Solutions with Nature as our Teacher:**

Problems of Mankind:

- 1) Exponential Growth of Population!**
- 2) Pollution** →
- 3) Lack of Resources**



Axiom 8 continued:

Does mankind need to *adopt a strict birth control* based on a **one child per family policy**, that was first introduced many years ago in China?

What is the meaning of Homo S?

S = Sapiens (wise and knowledgeable?) or

S = Selfish interested only in Money & Political Power with Money = Power?

A *rigorous interpretation* of the book of Prigogine and Sanders leads to the following Axiom 9:

“What is Life?”

Axioms continued...

9. (Prigogine/Stengers/Leuenberger): *The human Society is a living biological entity* consisting of *system relevant* organs such as *brain*



(world pool of scientists →)

heart (world bank system)

pumping blood (money) to

the *muscles* (all types of industry), to the *lungs*

(energy comb. plants →)

to the *digestive system*

(recycling and fertilizer industry).

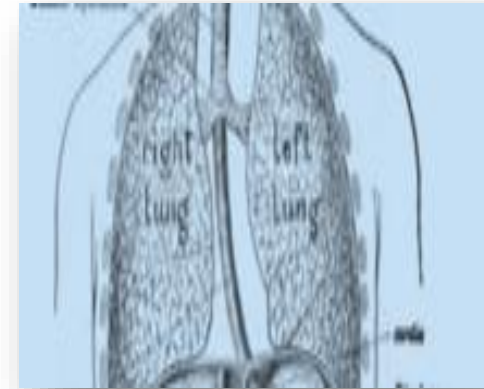
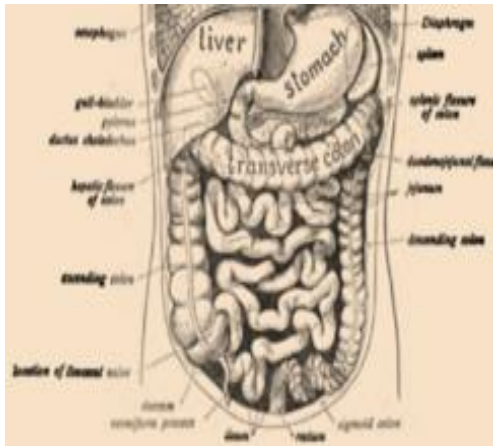
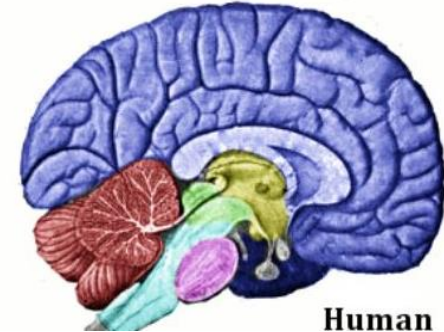

“The Life of Society” Axiom 9:

Human society’s *life* is in a

Dynamic Equilibrium as in case of the human being, using **a check and balance mechanism to stay healthy.**

The definition of a *society is an ensemble of people* such as a family, a tribe, a community, a party, a company, a state, a nation, the world population, etc.

The check and balance mechanism of the society is part of its culture and of its constitution adopted.

A practical example is the society of the **Swiss Federation** of 26 Cantons (States) in Europe:



Switzerland.

A WELL-BALANCED MECHANISM

1+26+2,250=1

Power is shared by the federal government, the 26 cantons and around 2,250 communes.

SUBSIDIARITY

The cantons and communes have authority over a wide range of matters (e.g. schools, hospitals, tax and policing) and a great deal of autonomy. The federal government only takes on tasks that the cantons and communes cannot manage alone.

Federalism is what allows the different aspects of Switzerland, with its four national languages and large geographical differences, to coexist. Federalism was one of the founding principles of the Swiss Confederation in 1848.

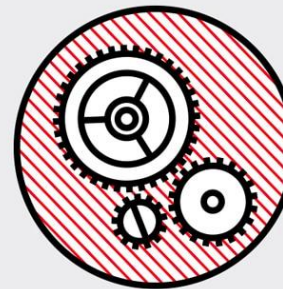

Every canton has its own constitution, parliament, government and courts. About a fifth of communes have their own parliament, in particular the cities.

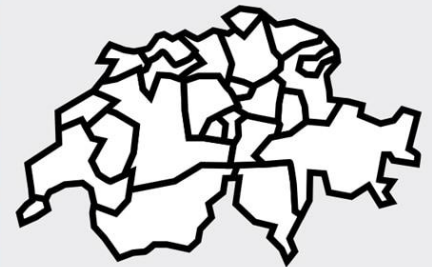

SWITZERLAND: From 1291 to 1848 = Old Swiss Confederation

suffered from internal disputes and numerous peasant revolts.

In 1848 Switzerland adopted and adapted the US constitution of 1787 as the only country in Europe.

- The 26 states have different cultures, languages and enjoy a maximum of freedom and power by financially supporting less rich cantons.
- “Natural Biodiversity” of parties for finding a compromise for residents, a “win-win” solution.
- A healthy Society has a Consciousness, a Soul!
- Test of Democracy: Voters are ready to increase

“The Life of the Society” Axiom 9 continued: Switzerland is ready

increase the tax burden, in case of a reason!

Stress Test of Federation: In 1979 voters agreed to create the Canton of Jura to **avoid** a “North Ireland” **conflict** between mainly **Protestant Bernese immigrants and Catholic residents!**
Also a **Brexit type of problem** could be **avoided!**

Switzerland is currently a Healthy Society in a dynamic equilibrium. It is important to stay healthy and safe by keeping its Direct Democracy.

Important: The evolutionary process in Nature follows **incremental and peaceful steps!**

“The Life of Society” Axiom 9:

Check & Balance Mech. *ChB-M*

Disease: Society’s dynamic equilibrium is *out of balance due to failure of the ChB-M.*

Failure of ChB-M provoked by environmental conditions such as climate change → flooding, drought, wildfires or result of natural disasters such as earthquakes, but also of wars etc.

History: A *sick society favors terrorism & bloody revolutions* → *collateral damages.*

Diagnose → *Cure by Changing the Framework Conditions.*

Thus, as a result of *Society’s Consciousness all problems can be resolved:* →

Securing Public Acceptance of Nano Technology.

In this context, a practical example of Manufacturing Nanoparticles in the pharmaceutical industry is discussed:

Spray - Freeze Drying as a Method of Choice for a safe Manufacturing and Handling of Nanoparticles and Nano Composites.

Started in 1980s (in cooperation with Glatt AG, Switzerland); 4 PhD projects at the University of Basel (A. Kahn, M. Mumenthaler, H.P. Mennet and M. Plitzko) until mid 90's leading to patents such as

Spray Freeze Drying Process Technological Background:

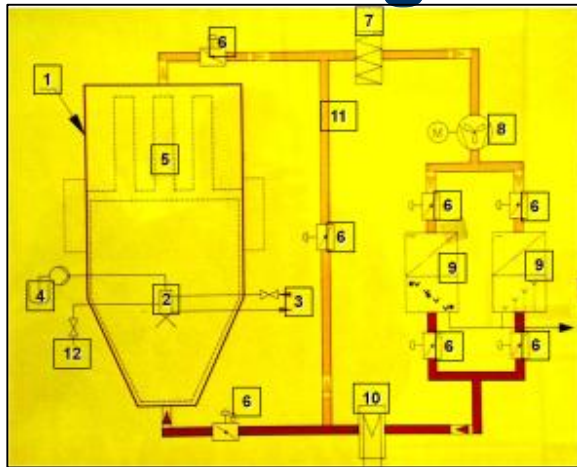

the US 6,584,782 B2 of July 1, 2003 as part of the 12 patent families of the Glatt Group with the name Hans Leuenberger as inventor.



Thus, a **3 step Quasi-Continuous Process** is needed.

For this purpose *three in-line fluidized bed (FB) towers* are necessary!

Spray Freeze Drying Process Technological Background

Three Fluidized Bed (FB) Towers are required:

- 1) **Spray freezing phase** at $T_{\text{AIR}} < -60^{\circ}\text{C}$ in the fluidized bed (FB) tower Nr. 1.
- 2) **Primary drying phase** at $T_p < -10^{\circ}\text{C}$ in the subsequent FB tower Nr.2.
- 3) **Secondary drying phase** at $T_s = \text{ambient temp.}$ in the FB tower Nr.3.

However, this patent (US 6,584,782 B2, July 1, 2003) based on a quasi-continuous process was not implemented by the Glatt group,

Spray Freeze Drying Process Technological Background



Dr. Bernhard Luy, my former PhD student, founded the start-up company MERIDION **successfully realizing a two step technology:**

- 1. particle formation and
- 2. dynamic bulk freeze drying.

Thus, no classical freeze drying problem due to heat transfer & vapor transport during sublimation in the vial!

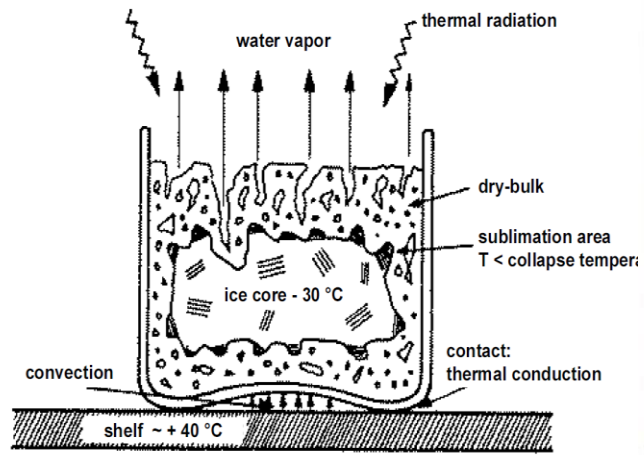

Spray Freeze Drying Process

2 Steps by MERIDION

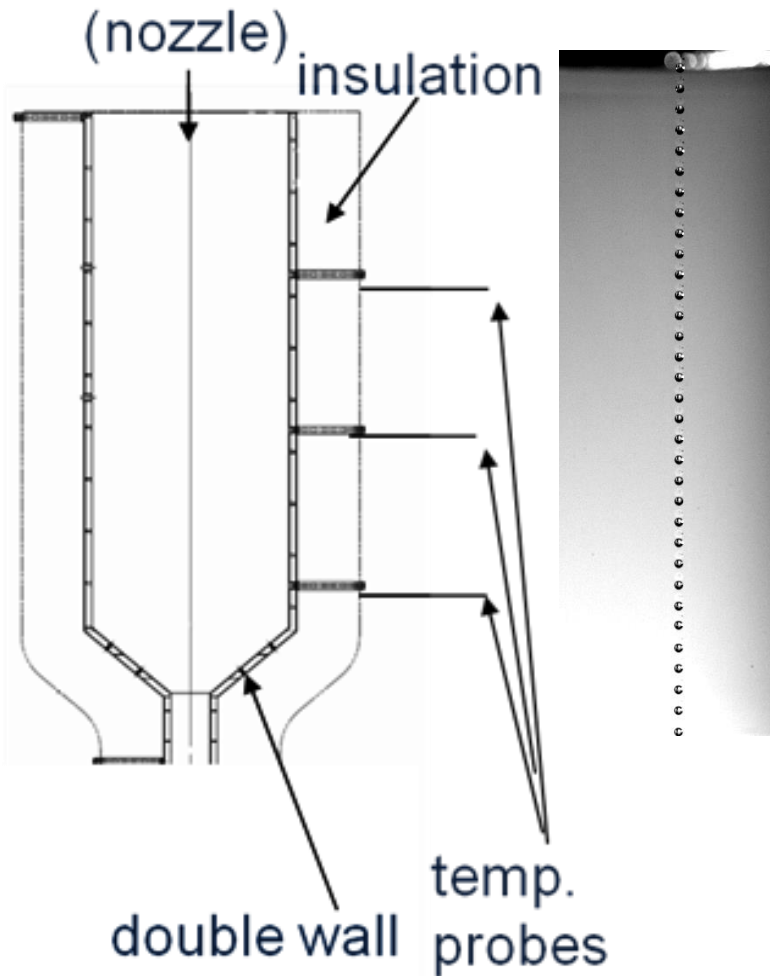

1-Spray Freezing: Generation of homogeneous frozen bulk microspheres by dispersing the liquid using frequency nozzles leading to

← **single droplets, which by gravity pass through a cooling zone, congealing to frozen spheres at ambient atmospheric pressure.**

Spray Freeze Drying Process

2 Steps by MERIDION



2- Dynamic Bulk Freeze Drying: *Lyophilization of Frozen Bulk.*

Frozen microspheres are lyophilized in a rotational vacuum freeze dryer while constant gentle mixing.

Sublimation energy is transferred by radiation and temperature controlled surfaces.

Spray Freeze Drying Process Aseptic Industrial Line

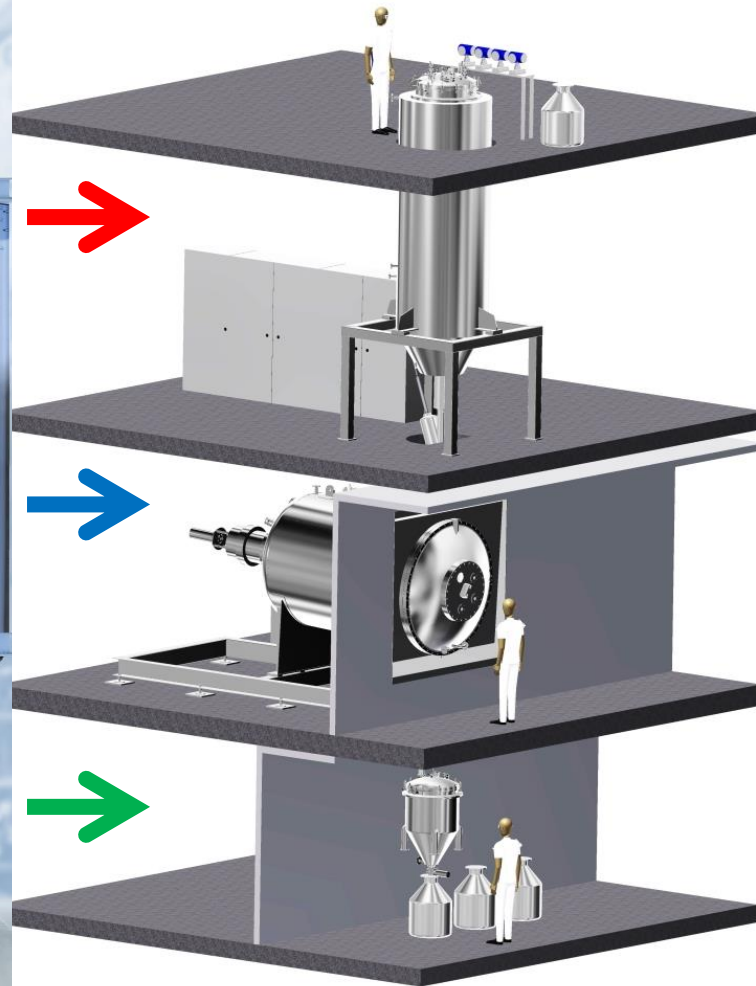
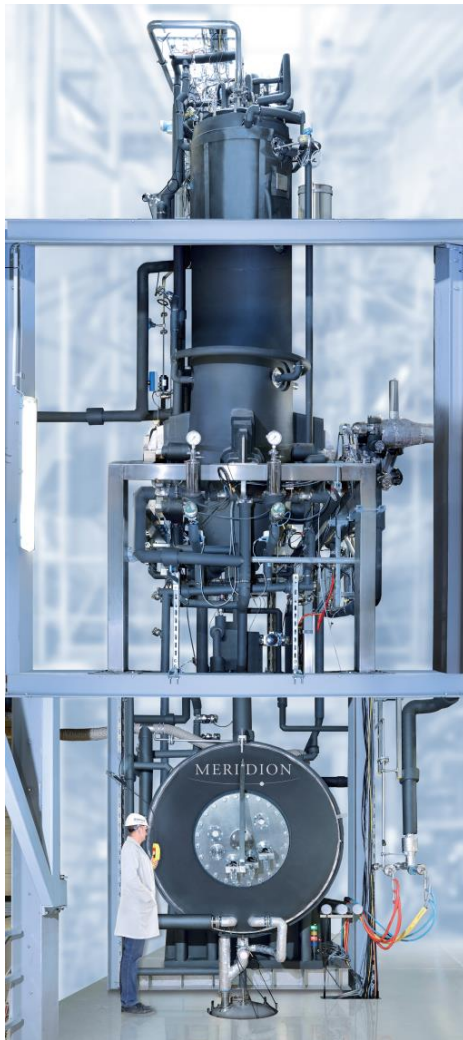

Nozzle for Liquid
Spray freezing chamber
Transfer
to dryer, incl.
vacuum flap
**Rotary FD with
closed charg.
& discharge**
Transfer Tube;
**Discharge
& filling of IBCs**

Spray Freeze Drying Process

Advantages of Platform

Manufacturing stable formulations of **poor water soluble drugs**, of *vaccines, biosimilars*, biologics, monoclonal antibodies, antibody-drug conjugates for **Precision Medicine**.

It is important to realize that this platform is a new disruptive technology leading to *instant soluble pellets*. → *As excellent clinical sample formulations* for phase I-III studies since **60%** of new potent drugs *show poor water solubility*.

*More details in **SWISS PHARMA 2021/3:***

Spray Freeze Drying Process

Contents SWISS PHARMA



- 1) **Editorial**
(Marcel Van de Voorde)
- 2) **Spray Freeze Drying P.**
(Hans Leuenberger, HL)
- 3) **Ethics & Nano** (HL)
- 4) **Swiss Pharmacy Educ.**
(G. Borchard / Chr. Moll)
- 5) **Negotiation & Conflict Management** (M. Ambuehl)
- 6) **Is a new University Educational Reform needed?** (M. Van de Voorde)

24/7 Manuf. Nanoparticles for Consumer Electronic Industry



**Multiple
MERIDION
Rotary
Freeze
Drying
Units as
a method
for 24/7
production**

Securing Public Acceptance of Manufacturing Nanoparticles

Manufacturing Nanoparticles for *medical use* are *safe since* medicinal products *are subject to regulations* by health authorities such as FDA, EMA, etc. *Thus, medicinal Nanoparticles are a blessing!*

This platform is a *technological solution* based on *scientific integrity*. Most important, a misconduct will be prosecuted. In addition, ALLEA, the European Federation of Academies and Humanities, is *representing more than 50 Academies* from over 40 EU and non-EU countries supporting the *EU Code of Conduct 2017*.

Securing Public Acceptance EU Code of Conduct 2017

The European Code of Conduct for **Scientific Integrity** provides the European research community with a framework for **self-regulation across all scientific disciplines and research areas. Is self-regulation sufficient or promoting a manufacturing site with a minimum of required standards?**

This question is **legitimate** since it was necessary for highly regulated medicinal products to establish **ICH, the International Council for Harmonization of Technical Requirements for Pharmaceuticals for Human Use.**

Securing Public Acceptance *ICH as a solution?*

Should ICH be limited to Technical Requirements? This issue is discussed in the document of IFPMA (International Federation of Pharmaceutical Manufacturers and Associations): “*IFPMA and Self-Regulation*”. However, IFPMA members realized to **strengthen their ethical conduct resulting in adopting explicit codes to assure compliance in the area of marketing & promotion.** This fact shows the **problem of loopholes**, since the **legal framework is different in each country and is not identical to the ethical conduct!** Thus, it is **possible to do a legal but unethical business!**

Problem of legal but unethical business:

The problems are invisible Nanoparticles that are not well known and part of pollution.

A typical example is Diesel Exhaust . These invisible Nanoparticles are a Curse and need further attention!

Regarding legal but unethical businesses: See details in the book “Ethics in Nanotechnology”, leading to the conclusion that a legal but unethical business should not be allowed. Misconduct must have legal consequences!

Unfortunately, legal but unethical business exist for centuries in various forms:

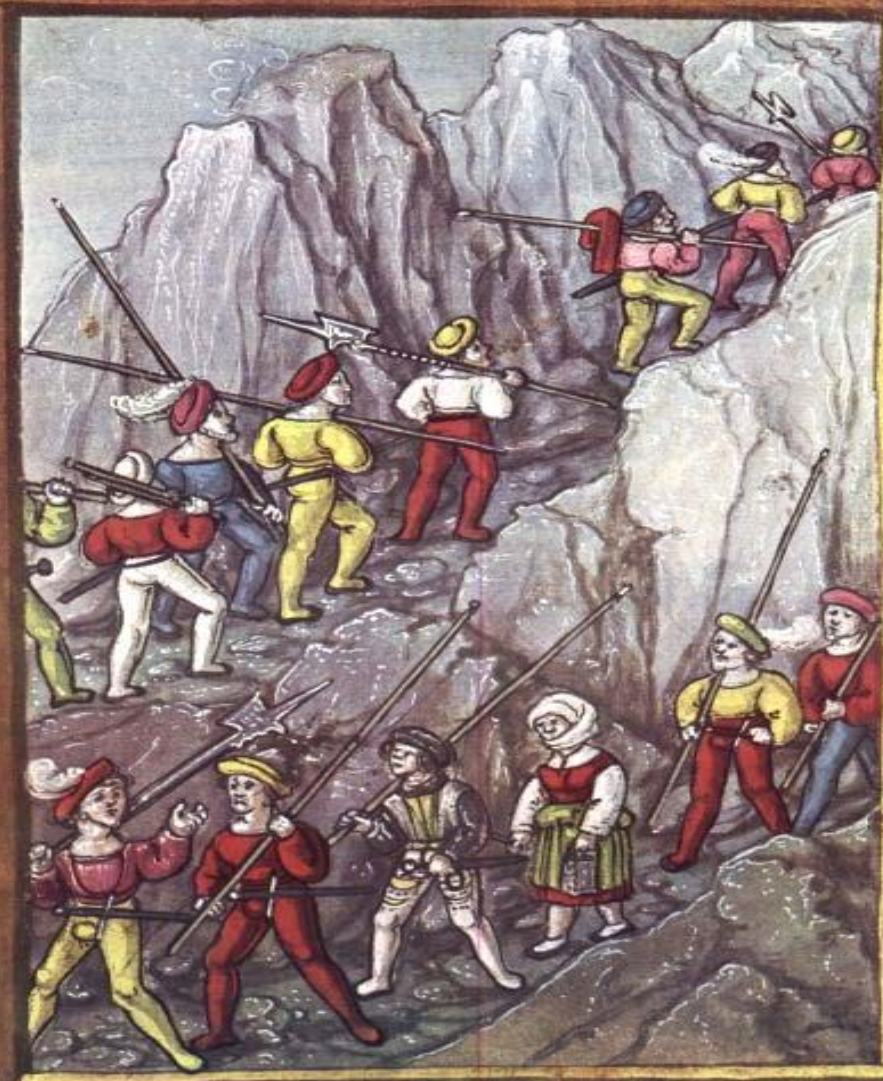

Before 1848 Swiss Cheese & Swiss Chocolate was not the main export article of Switzerland, but Human Trafficking, i.e. Swiss Mercenaries were the Income of the Nobility Governing the Old Swiss Confederation.

← Crossing the alps (D. Schilling 1517).

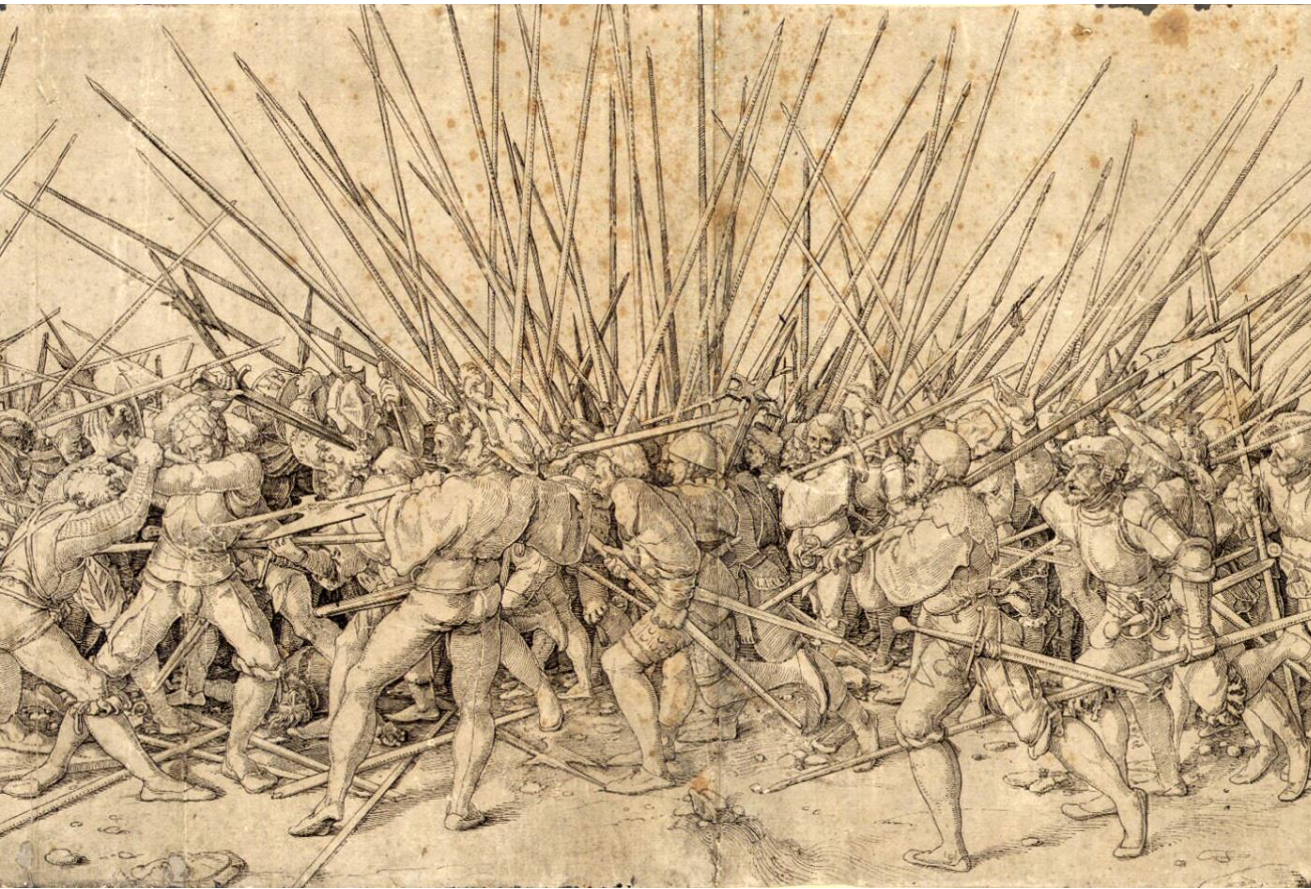

“Bad War”
(Holbein, the Younger in Basel 1528-1532).
Worst Case:
Swiss Mercenaries fought on both sides

during the religious 30 years War (1618-1648), i.e. **for the Catholics and the Protestants!**

SWISS GUARD OF VATICAN



*After 1848
Swiss were
only allowed
to serve the
**Pope for his
protection,**
forming the
smallest
army of
the world.*

SWISS GUARD OF VATICAN



| Strength | |
|---|---|
| 5,000 Condottieri militia 189 Swiss Guards | 20,000 + (mutinous) <ul style="list-style-type: none">• 14,000 German Landsknechts• 6,000 Spanish soldiers• Unclear number of Italian mercenaries |
| Casualties and losses | |
| 500 dead, wounded, or captured | 1,000–4,000 killed. (Around 8,000 killed by plague and disease after siege) |
| 45,000 civilians dead, wounded, or exiled (most were casualties of the disease and plague that crippled the city) | |

1527 Sack of Rome:
189 Swiss Guards
protected the Pope
& only 42 survived
during this battle!
Background: Pope
Clement VII believed
that Charles V, Holy
Roman Emperor,
wanted to dominate
the Catholic Church
and Italy.

*Is it possible to **justify War***

***Violence & Looting i.e. the Sack of Rome 1527
in the Name of a Religion?***

*Religion is the source of peace of mind without hate
and revenge.*

*Thanks to God's blessing and grace and as a result
of a personal evolutionary process, people have the
chance to get enlightened enjoying incredible
happiness and health.* Thus, religious freedom is
part of a healthy society leading to

***Axiom 10: The common denominator of all religions
is ethical conduct!***

THE ETHICAL CONDUCT

can be essentially realized by **implementing** the corresponding **exemplary rules** e.g. such as the **Ten Commandments**.

What about Religion & Science?
Einstein (1879-1955):

“A contemporary has said, not unjustly, that in this materialistic age of ours the serious scientific workers are the only profoundly religious people.”

Ref. Religion & Science 1930

THE ETHICAL CONDUCT

Since **society** can be deemed as a **biological living being**, this concept allows exploring the necessary prerequisites for securing **public acceptance of nanotechnology and beyond**.

Beyond means, to **accept all technologies** that **improve quality of human life**.

For this purpose the following axioms are required:
Axiom 11: *Common denominator of Marketing and Politics = Trustworthy Communication.*

THE ETHICAL CONDUCT

To be on the safe side, *Trustworthy Communication* must be based on *Trustworthy Sciences* leading to

Axiom 12: *Common denominator of all Trustworthy Sciences = Scientific Integrity and Integrity of Data.*

Thus, Trustworthy Communication based on Trustworthy Sciences , i.e. Scientific Integrity and Integrity of Data are

the Key Issues for Securing the Public Acceptance of Nanotechnology and Beyond:

Securing Public Acceptance

Conclusions

- Public acceptance is a **political issue**.
- Acceptance **secured** by **trustworthy politics** based on **scientific integrity** and **data integrity**.
- **Compliance** of **Legal Framework & Ethical Codex**.
- Law and Ethical Conduct need to be **enforceable**.

- Framework **Optimization** is a **Global Issue**: e.g.
- **ICH**, International Council for **Harmonization** of **Technical Requirements** for Pharmaceuticals for Human Use *should be complemented by an*
- International Council of **Harmonization of Laws and Ethical Conduct**.

What is Life? The initial axioms

based on the work by Prigogine define “Life of a **Virtual Patient**”, a **Supercomputer**, who can suffer from **Viral Infections**.

- **Second Law of Thermodynamics: Aging Process!**
Degradation of a Tablet
- **Percolation Law & Threshold** ➔ **Anti-Aging Effect!**
Creation of a Tablet: $X = S (p - p_c)^q$ (Axiom 2)
- **Natural peaceful evolutionary process with **no collateral damage** in a healthy system** ➔ **can be also realized in a healthy society!**
- **Percolation Threshold (Detail): Switch function of Computer Operating System!**

Can Life exist in 2D?

Conclusions

1) Explained by Stephen Hawking & Michio Kaku:

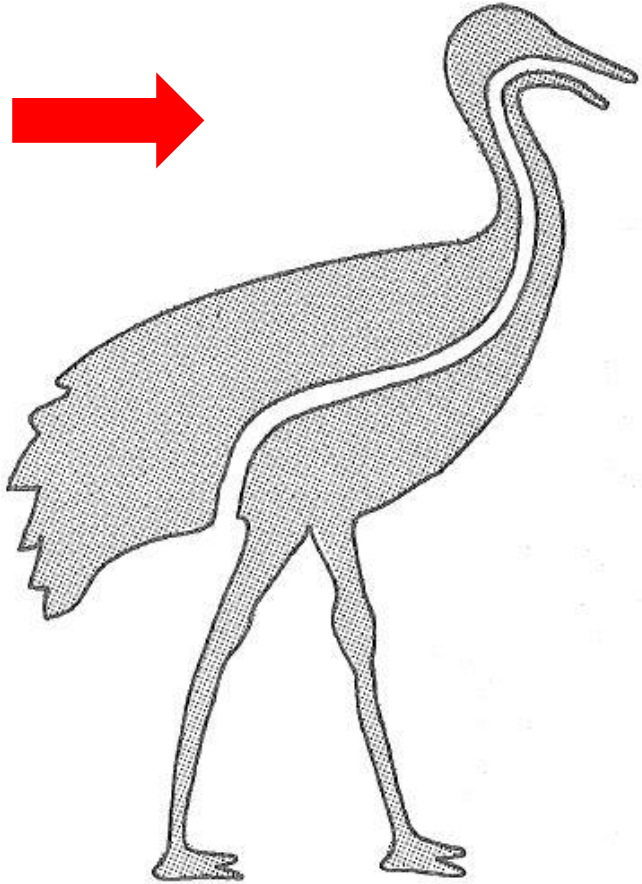

2) Percolation Theory shows that life can exist only in $\geq 3D$ due to the 3D percolation threshold that serves a bio **switch function** by the influx of an ingredient in a 3D compartment such as a cell that changes its functionality. **Thus, in terms of Formulation Science:** The influx of Oil in **an Oil/ Water** system leads to a **Water/Oil** System, i.e. to a **phase inversion!**

General Conclusions

Century of Nanoscience and Nanotechnology:

→ **Convergence** of Biology, Chemistry, and Physics! followed by

Century of Artificial Intelligence and In-silico Models of Complex Systems:

→ **Convergence** of all sciences and scales, *i.e. Natural, Medical & Humanities!*

→ *Is this fact triggering a new reform of University Education?*